

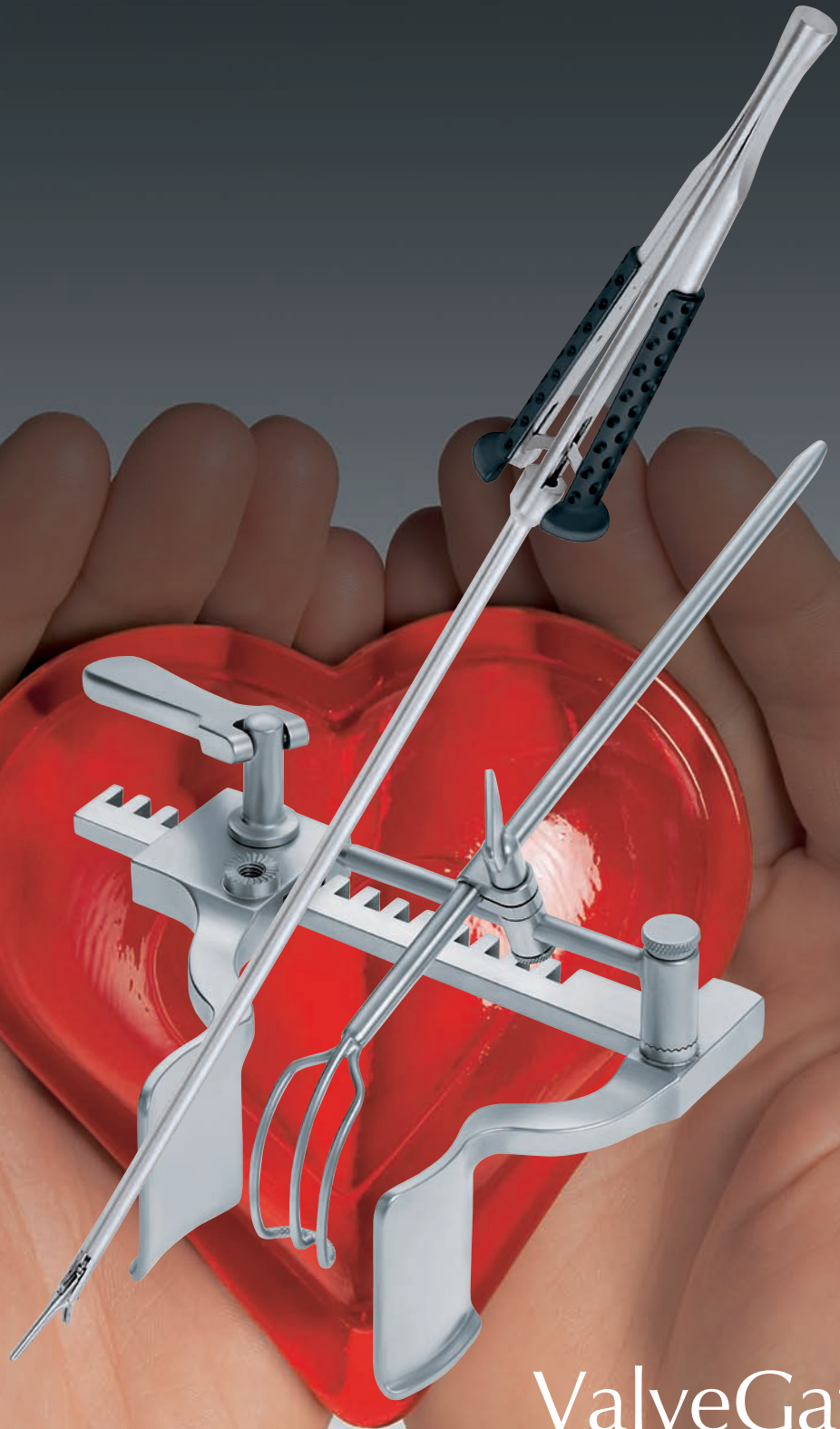

The better way to operate™

GEISTER



ValveGate™
Minimally Invasive
Valve Surgery

ValveGate™ Retractors and Tools



29-1395

ValveGate™ Mini-Thoracotomy Retractor with straight arms, 30x60mm blades with turnable crossbar (detachable) for accessories*

Recommended ValveGate™ Accessories:

29-1395.TB	Extra turnable crossbar
29-1500.BH	Malleable Atrial Retractor 20mm
29-1500.HS	Cooley Atrial Hook 20mm curved basket
29-1501.HS	Cooley Atrial Hook 20mm straight basket
29-1500.HS/D	Cooley Atrial Hook 20mm curved basket, long shaft
29-1428	Fixation Clamp
29-1437	Multi-Purpose Spatula

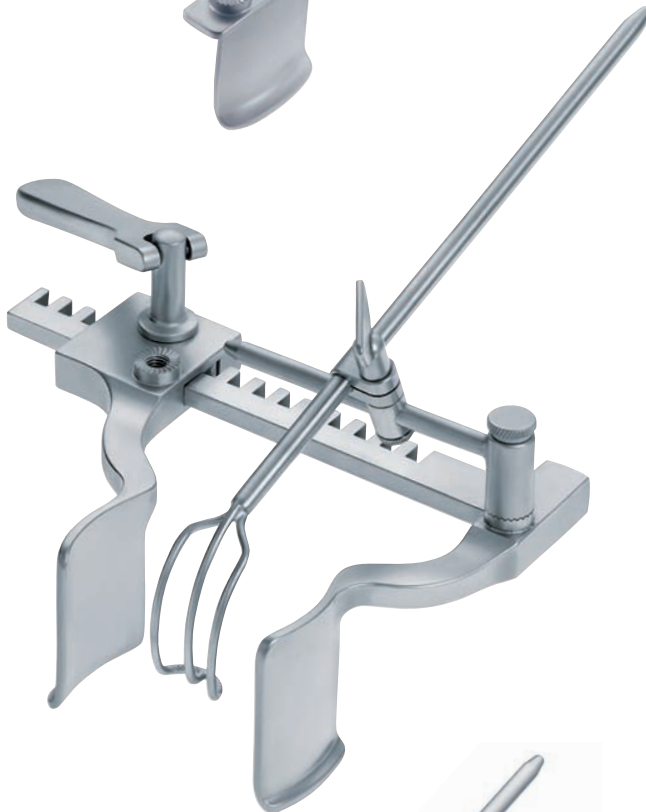

NEW
29-1397.06
ValveGate™ Suture Ring 6mm with removable springs (fits on all ValveGate™ Mini-Thoracotomy Retractors)

29-1397.08
as above, but 8mm

29-1390

ValveGate™ Mini-Thoracotomy Retractor with curved arms, 30x60mm blades with strong spreading bar and turnable crossbar (detachable) for accessories*

29-1396

ValveGate™ Mini-Thoracotomy Retractor with hinged arms, 2x2 exchangeable parallel blades 36x40mm and 36x55mm, turnable crossbar (detachable) for accessories*

29-1396.E2

as above, but 2x2 tubular blades 40x50mm and 40x70mm

29-1396.E3

as above, but 3x2 tubular blades 40x30mm and 40x50mm and 40x70mm

* shown with 29-1428 and 29-1500.HS (not included)

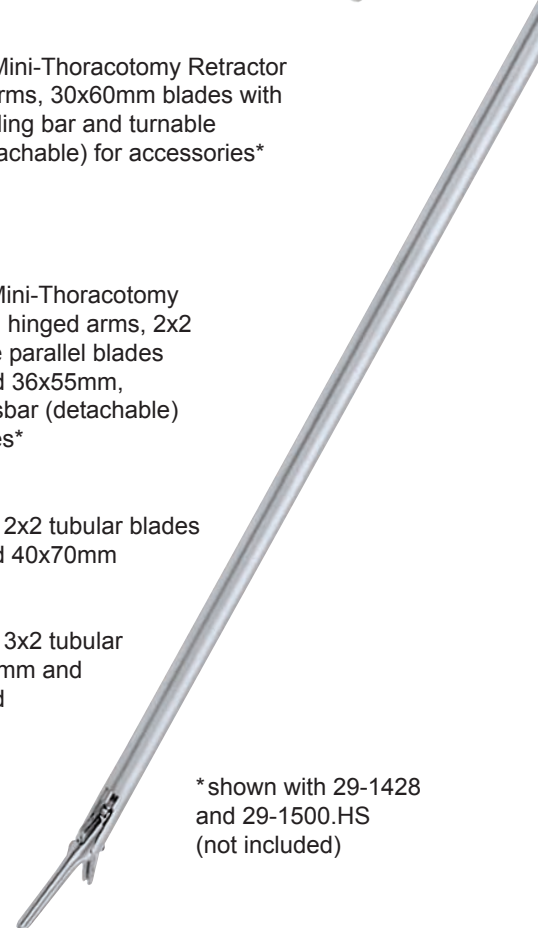
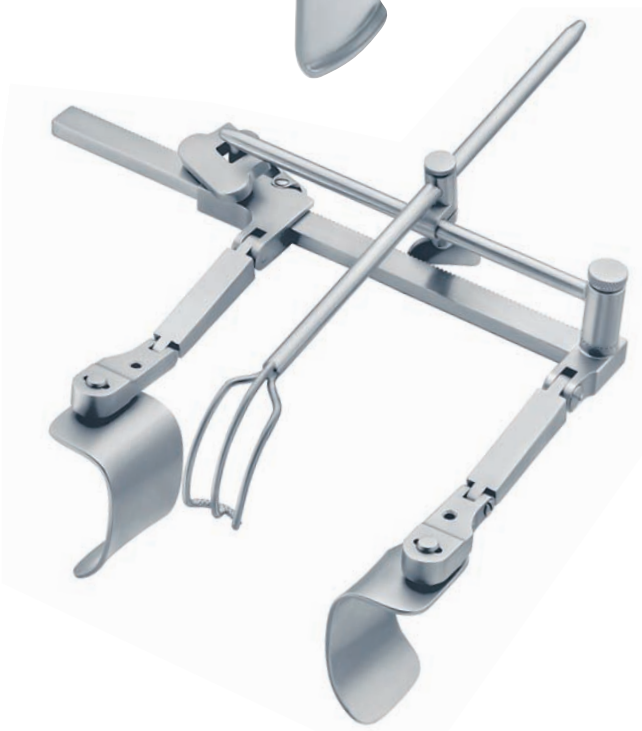



Innovative MIS Instruments for Valve Surgery, ultra-lightweight, perfectly balanced, with durable hard-anodized aluminium handle and integrated cleaning port.



ValveGate™ Scissors

- 34-7830 15° curved
- 34-7831 Jameson-style, curved, with tenotomy tips
- 34-7835 30° curved
- 34-7840 70° curved
- 34-7862 45° Potts-style
- 34-7860 125° Potts-style
- 34-7833 Robust Scissors 15° curved, 7mm shaft

NEW

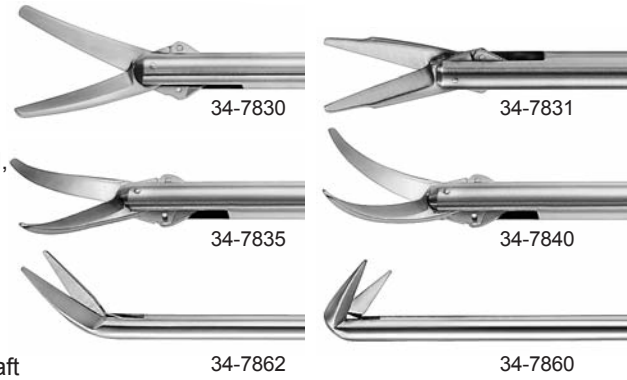

ValveGate™ Clip Applying Forceps

- 34-7460 small, for use with SLS/VitalitecClips
- 34-7460.HZ small, for use with Horizon Clips
- 34-7462 medium, for use with SLS/Vitalitec Clips
- 34-7462.HZ medium, for use with Horizon Clips



ValveGate™ Needle Holders with ratchet

- 34-7800 TC straight jaw
- 34-7802 TC curved jaw
- 34-7805 TC Ryder jaw
- 34-7806 TC curved, mini jaw, fine 3mm shaft



ValveGate™ DeBakey Graspers

- 34-7820 1x2 AG, small jaw
- 34-7821 1x2 AG, small jaw, angled upwards
- 34-7822 1x2 AG, small jaw, angled left
- 34-7824 Resano jaw for valves
- 34-7825 2x3 AG, wide jaw
- 34-7826 2x3 AG, wide jaw, fine teeth, gentle grip
- 34-7827 1x2 AG, delicate jaw, 3mm malleable shaft

NEW

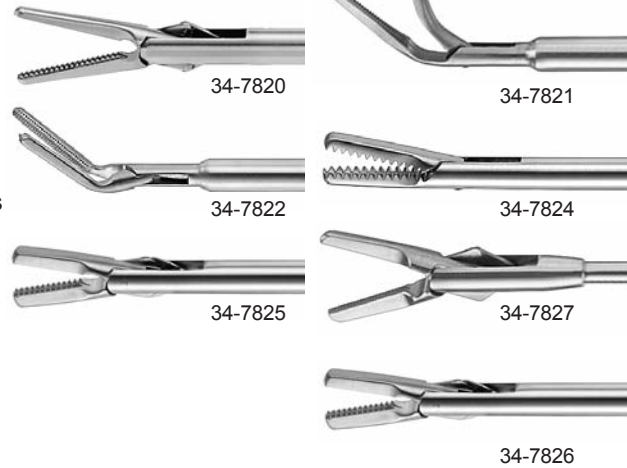

ValveGate™ Dissecting Forceps

- 34-7828 Gemini-style, smooth, dilating action



ValveGate™ Knot Pusher

- 34-7850 push to close
- 34-7851 push to open

NEW

Standard working length 25cm/10" for minimally invasive valve surgery. For shorter 17cm/6 3/4" working length (e.g. for open cardiac surgery and daily practice without switching instrument types) add "S" behind article number, for longer 30cm/12" working length (e.g. for thoracoscopy, laparoscopy etc.) add "L" behind article number when ordering.

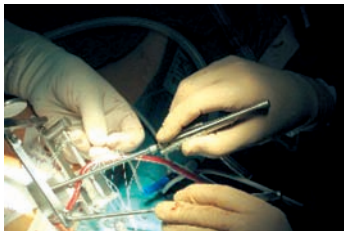
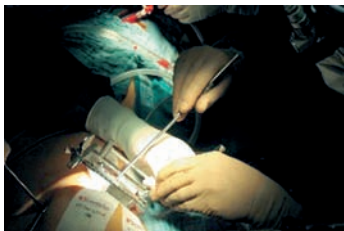
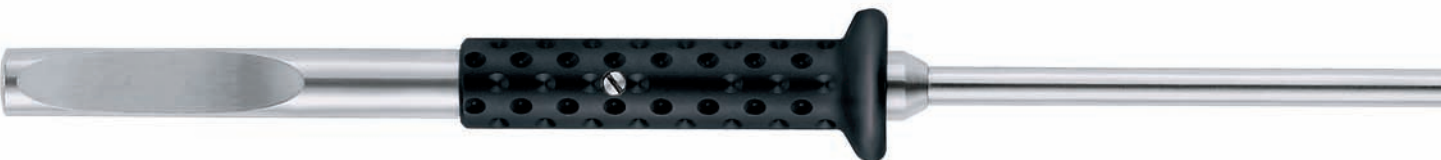

Suture Ruler (Chordae Tendinae Measuring and Knotting Device for expanded PTFE sutures)

03-5409 ValveGate™ Suture Ruler / 3 – 60mm, 34cm/13¼"



ValveGate™ Knotting Devices for chordal reconstruction with ePTFE sutures

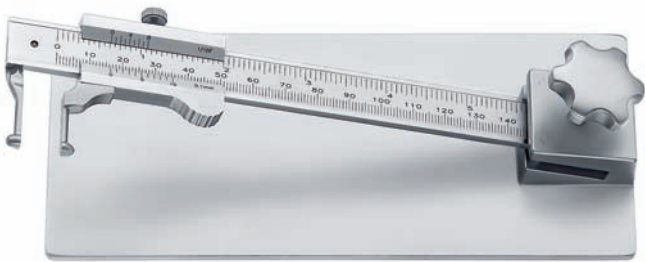

03-5420 ValveGate™ Knotting Device

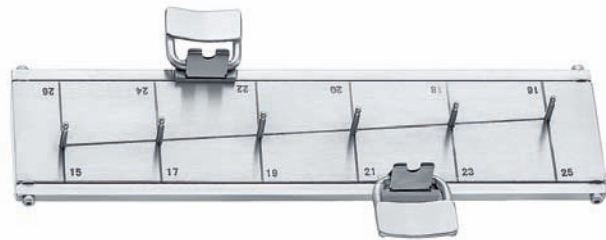

03-5425 Shibata Chordae System 15-26mm, facilitates chordal loop making



03-8000 Crawford Suture Holding Ring 23cm

NEW



34-7496 ValveGate™ Knot Pusher with disc 34cm/13½"



34-7486 ValveGate™ Fine Nerve and Vessel Hook 35cm/13¾"



34-7485 ValveGate™ Nerve and Vessel Hook 35cm/13¾"



34-7484 ValveGate™ Vessel Hook 35cm/13¾"



34-7475 ValveGate™ Suture Catcher 35,5cm/14"



34-7480 ValveGate™ Magnetic Retriever 35cm/13¾"

NEW



16-2011 Scalpel Blades #11 (pack of 100, sterile)

34-7471 ValveGate™ Scalpel Blade Holder (without blades) 37cm/14½"



16-2065 Mini Blades (pack of 10, sterile)

34-7470 ValveGate™ Mini Blade Holder (without blades) 37cm/14½"



34-7465 ValveGate™ Valve Pusher 35cm/13¾"

Cardioplegia Needles



- 18-0050 ValveGate™ Cardioplegia Needle / 30.5cm/12½" ø 2mm (Bredschneider Cardioplegia)
- 18-0051 ValveGate™ Cardioplegia Needle / 30.5cm/12½" ø 3mm (4:1 Cardioplegia)



- 34-7495 ValveGate™ Knot Pusher with slot 34cm/13½"

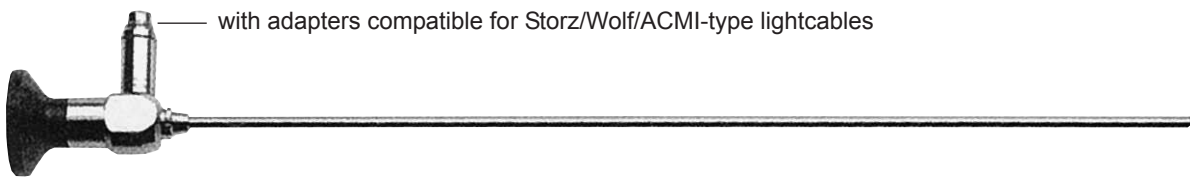

- 34-0960.AC ValveGate™ Endoscope Ø 5mm 0°, 30cm/12", autoclavable, universal eyepiece for C-Mount adapters
- 34-0961.AC ValveGate™ Endoscope Ø 5mm 30°, 30cm/12", autoclavable, universal eyepiece for C-Mount adapters

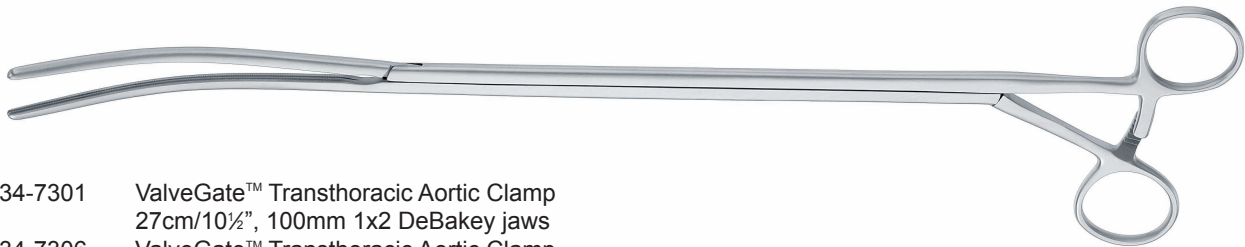

- 34-7301 ValveGate™ Transthoracic Aortic Clamp
27cm/10½", 100mm 1x2 DeBakey jaws
- 34-7306 ValveGate™ Transthoracic Aortic Clamp
27cm/10½", 100mm 2x3 DeBakey jaws

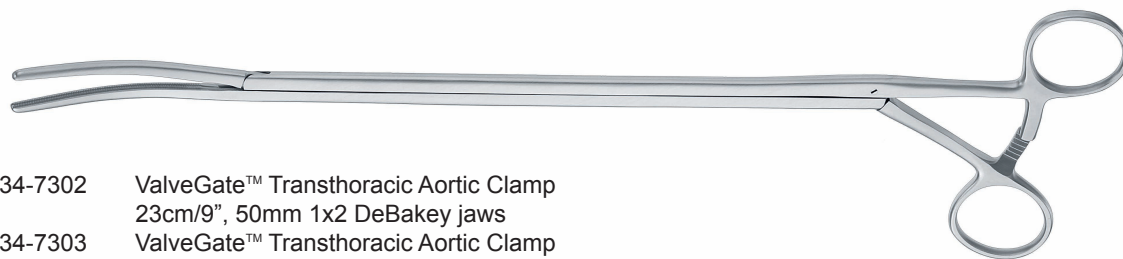

- 34-7302 ValveGate™ Transthoracic Aortic Clamp
23cm/9", 50mm 1x2 DeBakey jaws
- 34-7303 ValveGate™ Transthoracic Aortic Clamp
25.5cm/10", 75mm 1x2 DeBakey jaws

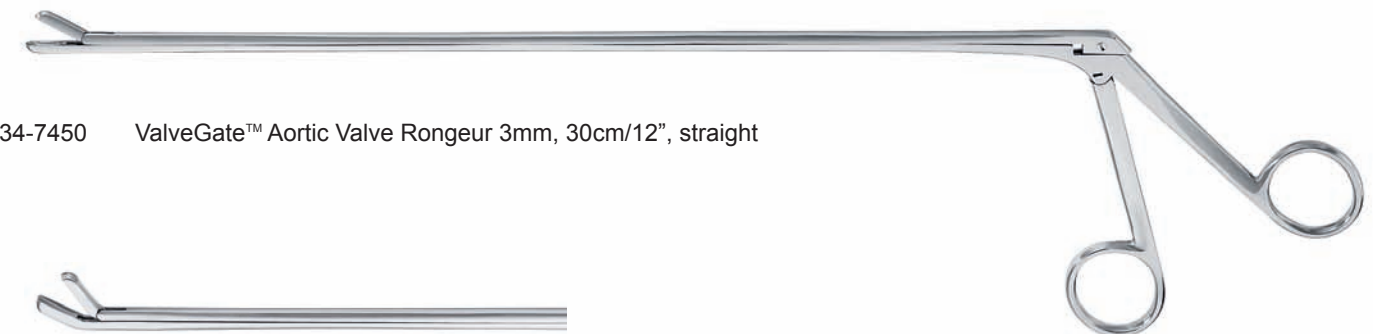

- 34-7450 ValveGate™ Aortic Valve Rongeur 3mm, 30cm/12", straight



- 34-7451 ValveGate™ Aortic Valve Rongeur 3mm, 30cm/12" 30°, upwards

ValveGate™ Accessories



- 29-1380 ValveGate™ Set of 6 **Mitral** Blades with Holder and Introducer
- 29-1379 ValveGate™ Set of 6 **Tricuspidal** Blades with Holder and Introducer



29-1481G Iron-Assistant™ Instrument Holder, extra long straight bar

29-1481 Iron-Assistant™ Instrument Holder, L-shaped bar
29-1481/I ditto, insulated for use with hf-surgery

29-1482 Iron-Assistant™ Endoscope Holder straight bar
29-1482/I ditto, insulated for use with hf-surgery

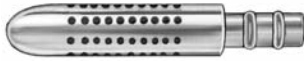

- 18-4520 Ross Ventricular Vent, Adult 3/16"
- 18-4521 Ross Ventricular Vent, Child 3/16"
- 18-4522 Ross Ventricular Vent, Infant 1/8"



- 34-0855 Thoracic Trocar 6mm



- 34-7510 Flexible Trocar 6mm 70mm
- 34-7511 Flexible Trocar 6mm 100mm



- 20-0351 DeBakey Bulldog Clamp straight 9cm/3 1/2"
- 20-0352 DeBakey Bulldog Clamp straight 10.5cm/4"

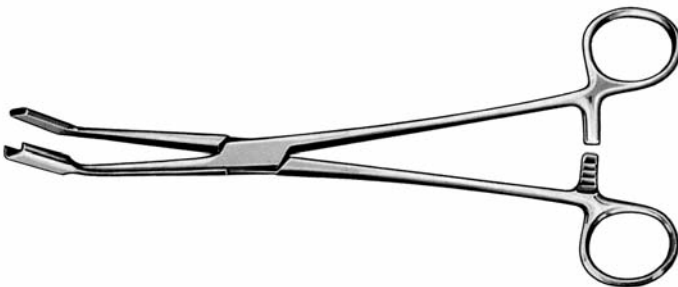

- 20-0378 Bulldog Clamp Applying Forceps, 24cm/9 1/2"

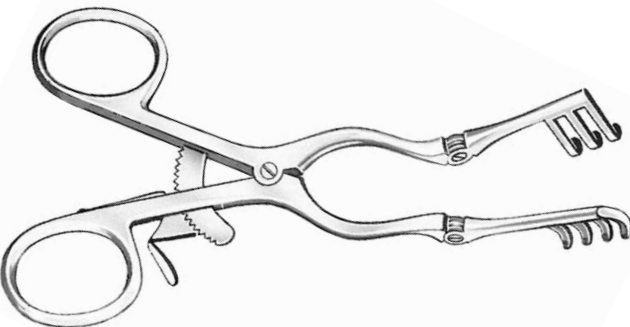

- 30-0740 Cone Retractor 14,5cm/5 3/4" deep pattern



- 30-0546.16 Memory Malleable Spatula 16mm 18cm/7"
- 30-0546.19 Memory Malleable Spatula 19mm 18cm/7"
- 30-0546.24 Memory Malleable Spatula 24mm 18cm/7"

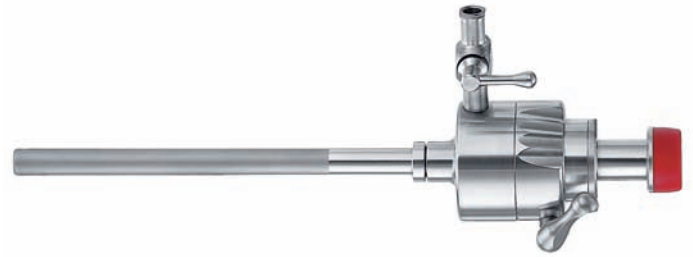

- 34-0953 Automatic Trocar Sleeve 5.5mm with manual opening



- 34-0956 Trocar 5.5mm, pyramidal point



- 34-3400 Veress Insufflation Needle 120mm



- 33-1530H Insufflator 30l/min with gas heater

Technical data: Insufflation pressure: 0 – 30 mmHg,
 Power supply: 100 – 240 VAC, 50 – 60 Hz, 65W
 Dimensions: (WxHxD) 355x103x253mm, weight: 7kg
 Gas: carbon dioxide (medical), gas connection: UNF 7/16"
 Class/Type: 2b/BF
 Manufactured and tested acc. IEC 601-1, EN 60601-1, 93/42 ECC
 Delivery contains: Insufflator, mains cable, CO₂ high pressure tube UNF to German gas connection, Wrench set: SW15/SW30, Sterile filter, System gas heater with tube set, User manual

- 33-1532 Spare Tube Set with heat exchanger 2.5m
- 33-1533 Spare Sterile Filters (pack/50 pcs.)

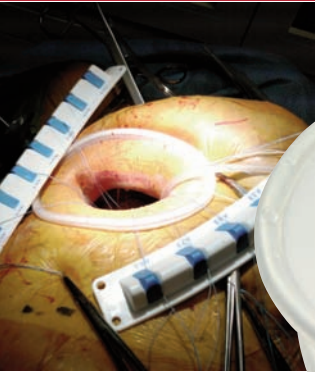

ValveGate™ Soft Tissue Protector, disposable, single use, sterile. Used for protecting and retracting soft tissue in combination with mini-thoracotomy retractors or instead of a retractor. Also recommended for use in transcatheter valve procedures and thoracic V.A.T.S. procedures with small incisions.

- 29-1399 Regular Size, incision approx. 60-90mm
- 29-1399S Small Size, incision approx. 20-50mm

- 34-7499 Flushing Adapter
- 34-7499B Flushing Adapter with lock to shaft



77-3605 Modular ValveGate™ Plastic Container System

502x239x102mm double level assembly 4" deep with mat in base and upper insert with silicone strips for up to 10 instruments



77-8000 Ultrasonic Desinfector and Cleaner
Dimensions 860x490x415mm, weight 40kg

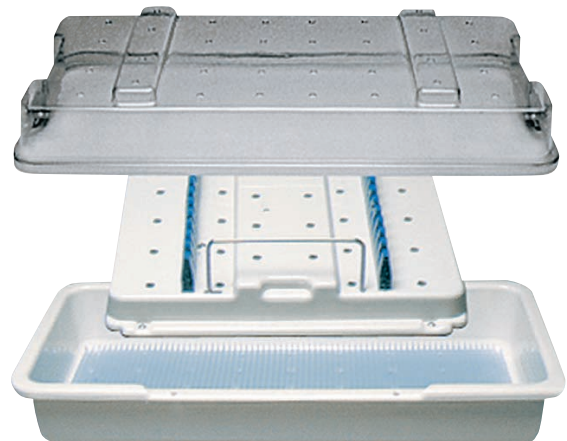

77-3600 Convertible ValveGate™ Plastic Container System

464x190x70mm with mat in base and upper insert with tri-level silicone strips for up to 12 instruments

© 2009 · Geister · All rights reserved.



Geister Medizintechnik GmbH
FöhrenstraÙ e 2
D-78532 Tuttlingen/Germany
Telefon +49 (0) 7461 - 966 240
Telefax +49 (0) 7461 - 966 2422
E-mail info@geister.com
Internet www.geister.com

Distributor