

Marberger

Vein and Aortic Valve Retractor



Cushing

Vein Retractor

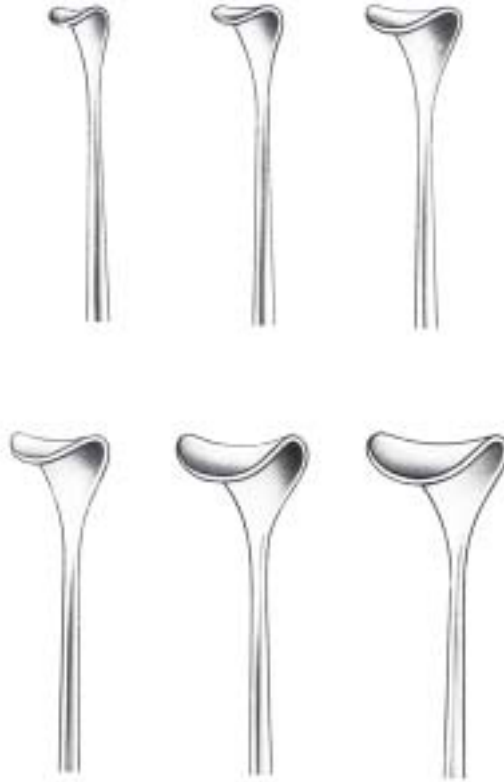

Malleable

Length	Width	Art.-No.
24 cm / 9 1/2"	4 mm	30-0099
24 cm / 9 1/2"	6 mm	30-0100
24 cm / 9 1/2"	8 mm	30-0101
24 cm / 9 1/2"	12 mm	30-0102
24 cm / 9 1/2"	15 mm	30-0103
24 cm / 9 1/2"	17 mm	30-0104
24 cm / 9 1/2"	20 mm	30-0105
24 cm / 9 1/2"	23 mm	30-0106

Not malleable

Length	Width	Art.-No.
24 cm / 9 1/2"	8 mm	30-0121
24 cm / 9 1/2"	10 mm	30-0122
24 cm / 9 1/2"	12 mm	30-0123
24 cm / 9 1/2"	14 mm	30-0124
24 cm / 9 1/2"	16 mm	30-0125
24 cm / 9 1/2"	18 mm	30-0126

Aortic Valve Retractors



Shaft malleable
270 mm / 10³/₄"

	Art.-No.
17 x 21 mm	30-0388.01
16 x 23 mm	30-0388.02
20 x 25 mm	30-0388.03
24 x 27 mm	30-0388.04
28 x 20 mm	30-0388.05
28 x 29 mm	30-0388.06

Harrington
Splanchnic Retractor



	Art.-No.
127 x 40 mm	30-0365
127 x 62 mm	30-0366

Blanco
Valve Leaflet Retractor



Length	Width	Art.-No.
28 cm / 11"	5 mm	30-0090
28 cm / 11"	7 mm	30-0091
28 cm / 11"	10 mm	30-0092

Ross
Aortic Hooks



Fig.	Length cm / "	Size mm	Art.-No.
1	24 / 9½	16 x 15	30-0390
2	24 / 9½	23 x 13	30-0391
3	24 / 9½	24 x 16	30-0392
4	24 / 9½	27 x 13	30-0393
5	24 / 9½	27 x 27	30-0394
6	24 / 9½	25 x 39	30-0395

Crawford
Aortic Hooks



Fig.	Length cm / "	Size mm	Art.-No.
1	19 / 7½	15 x 15	30-0355
2	19 / 7½	15 x 23	30-0356

Allison
Lung Spatulas

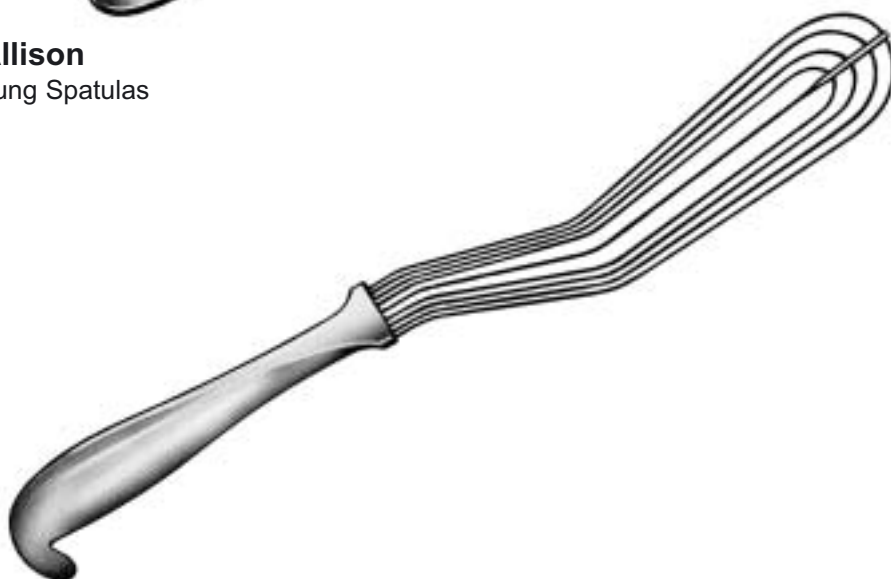

Length	Size	Art.-No.
32 cm / 12½"	for adults	30-0360
26 cm / 10¼"	for children	30-0361

Davidson
Scapula Retractors



Length	Size	Art.-No.
16 cm / 6 1/4"	75 x 50 mm	30-0350
16 cm / 6 1/4"	75 x 90 mm	30-0352

Cooley
Atrial Retractor, European Pattern



Size	Bending	Art.-No.
45 x 45 mm	right	30-0400
45 x 45 mm	right serrated	30-0402
15 x 45 mm	left	30-0404

Atrial Retractor, USA Pattern

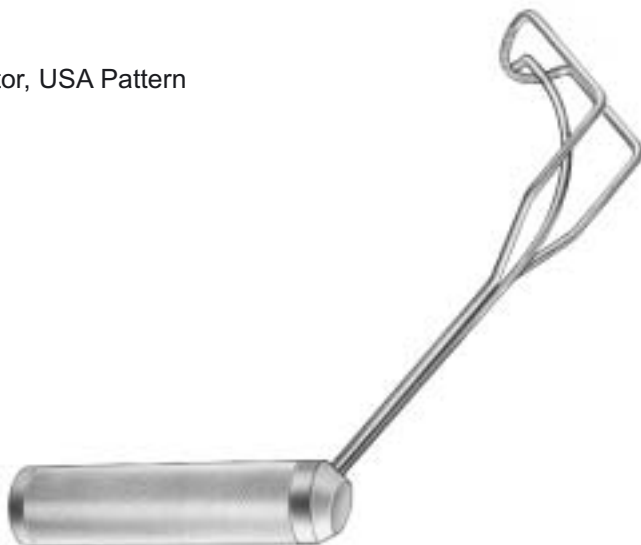

serrated

Size	Bending	Art.-No.
45 x 50 mm	right, deep	30-0410
18 x 30 mm	right	30-0411
35 x 38 mm	right	30-0413
45 x 48 mm	right	30-0414
17 x 19 mm	left	30-0417
38 x 19 mm	left	30-0416
45 x 20 mm	left	30-0415

Tudor-Edwards (UK)
Scapular Retractor



30-0495 16.5 cm / 6 1/2", 45 x 50 mm

Brock's (UK)
Erector Spinae / Back End Retractor



30-0497 19 cm / 7 1/2", 13 x 29 mm

Brompton (UK)
Erector Spinae / Back End Retractor



30-0496 19 cm / 7 1/2", 13 x 26 mm

Cleland's (UK)
Valve Leaflet Retractor



30-0494 25 cm / 10", 10 mm

Brock's (UK)
Atrial Retractors



30-0397 19 cm / 7 1/2", 5 mm

30-0398 19 cm / 7 1/2", 10 mm

30-0399 19 cm / 7 1/2", 12 mm

Langenbeck (UK)
Retractors



30-0005 20.5 cm / 8", 6 x 22 mm

30-0006 20.5 cm / 8", 12 x 45 mm

30-0007 20.5 cm / 8", 25 x 62 mm

30-0008 20.5 cm / 8", 18 x 90 mm

Valve Leaflet



30-0354 21 cm / 8 1/4", 7/10 mm

Zenker

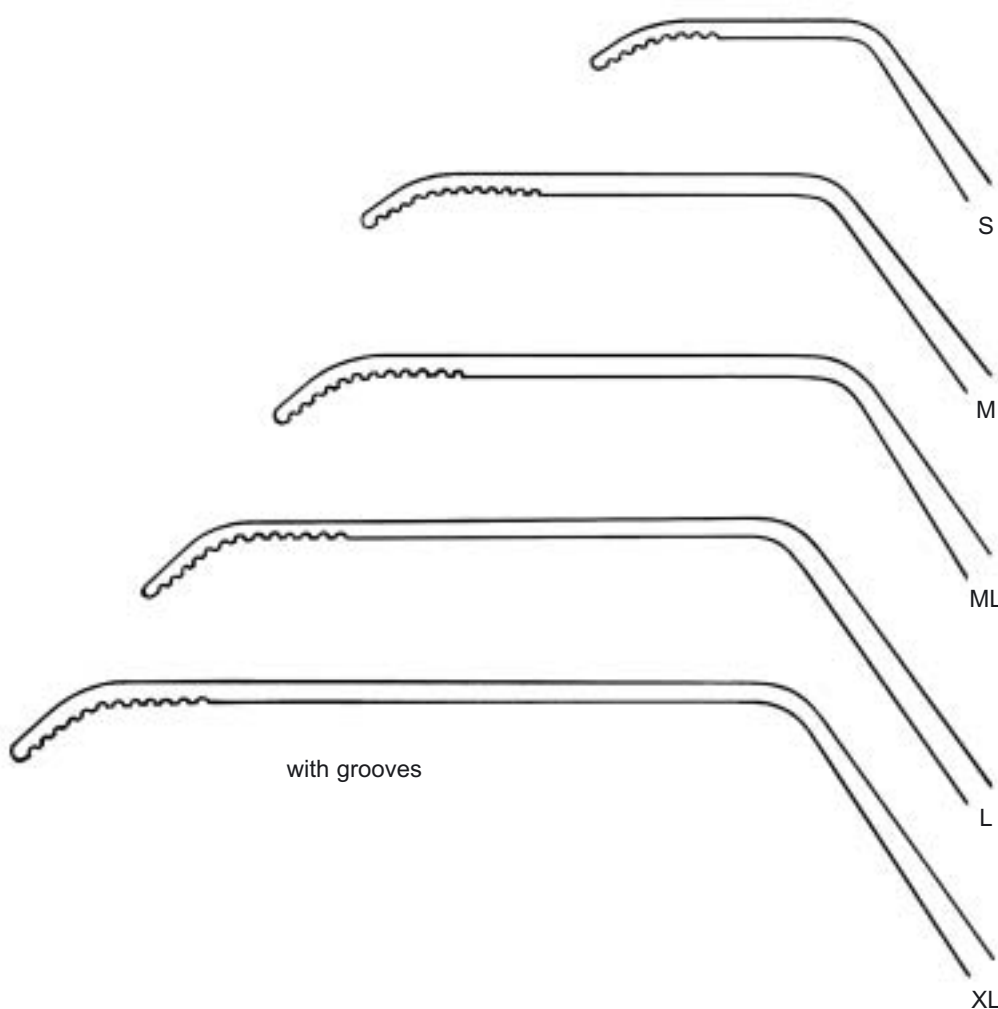
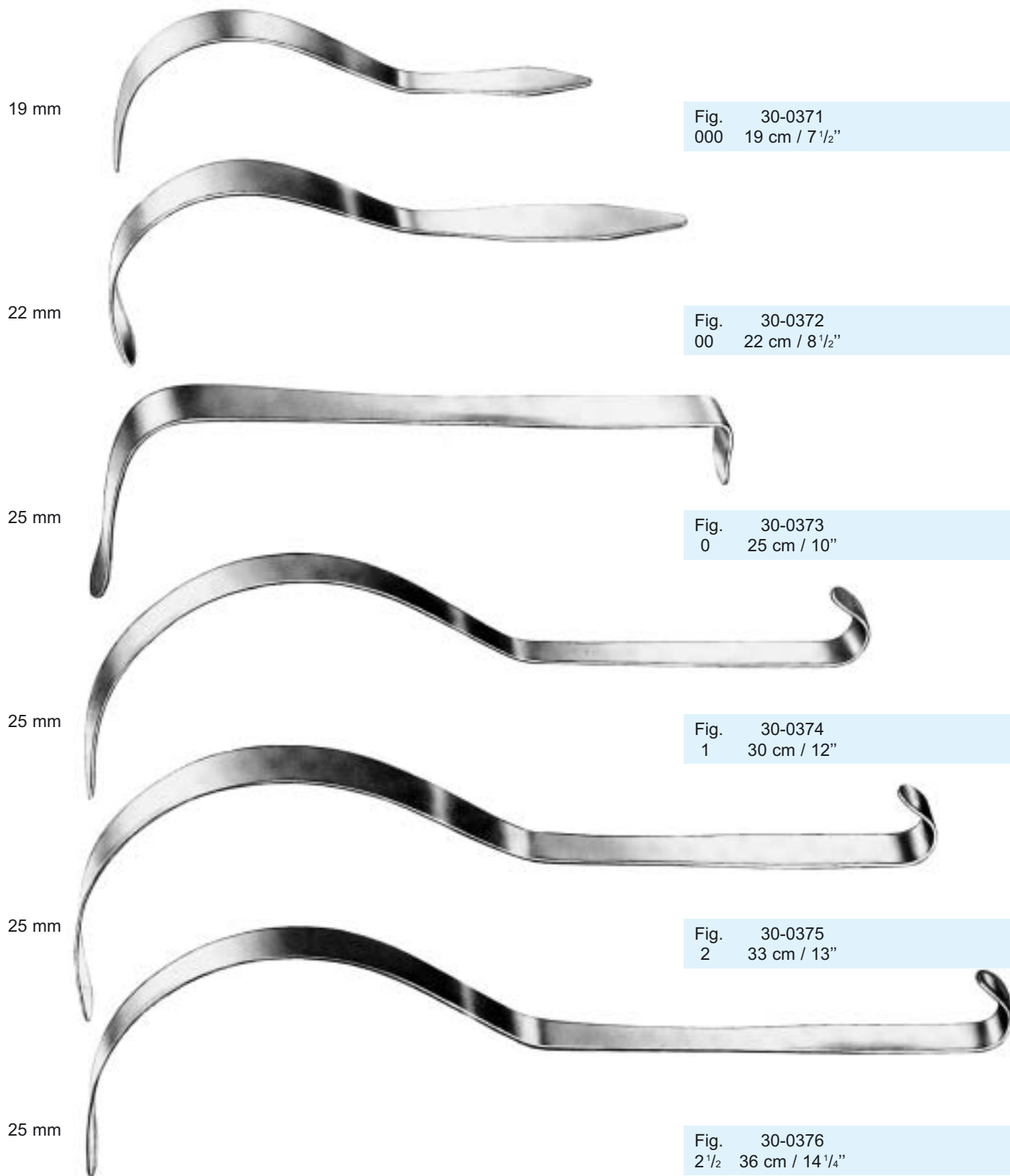

Fig.	Size	Art.-No.
S	35 x 8 mm	30-0200
M	60 x 12 mm	30-0201
ML	75 x 12 mm	30-0202
L	85 x 20 mm	30-0203
XL	100 x 25 mm	30-0204

Deaver



Deaver



38 mm

Fig. 30-0377
3 30 cm / 12"



50 mm

Fig. 30-0378
4 30 cm / 12"



75 mm

Fig. 30-0379
5 30 cm / 12"

Allison

Extra large Lung spatula

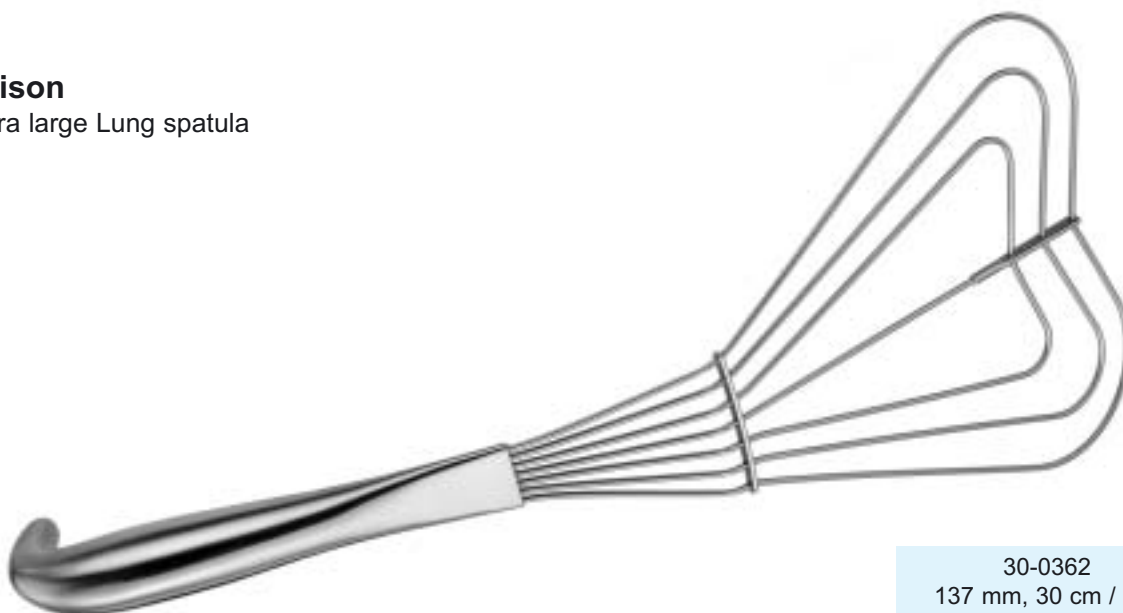

30-0362
137 mm, 30 cm / 12"

Slade

Baby-Allison Lung Spatula

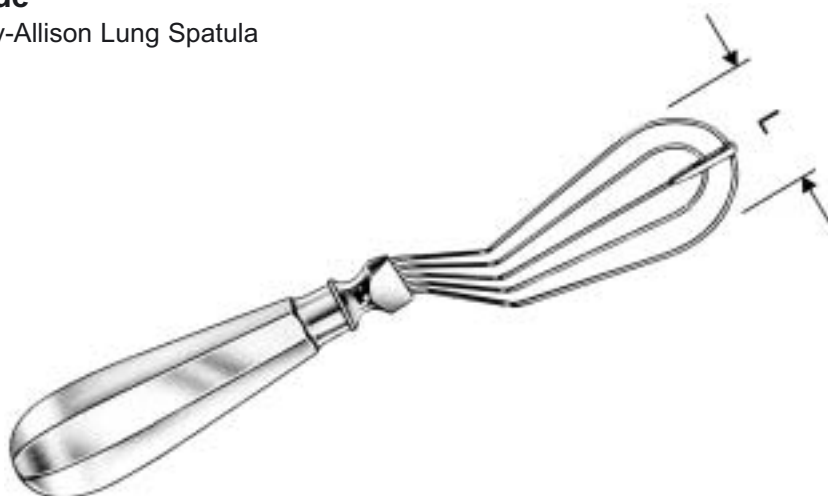

30-0363
L = 42 mm

30-0364
L = 23 mm

Walton

Copper Retractors/Abdominal Spatulas



	200 mm 8"	250 mm 10"	330 mm 13"
6 mm	30-0530		
8 mm	30-0531		
10 mm	30-0532		
12 mm	30-0533		
17 mm	30-0534		
20 mm	30-0535		30-0520
25 mm	30-0536	30-0537	30-0521
30 mm			30-0522
35 mm			30-0523
40 mm			30-0524
50 mm			30-0525
75 mm			30-0527

Richardson-Eastman

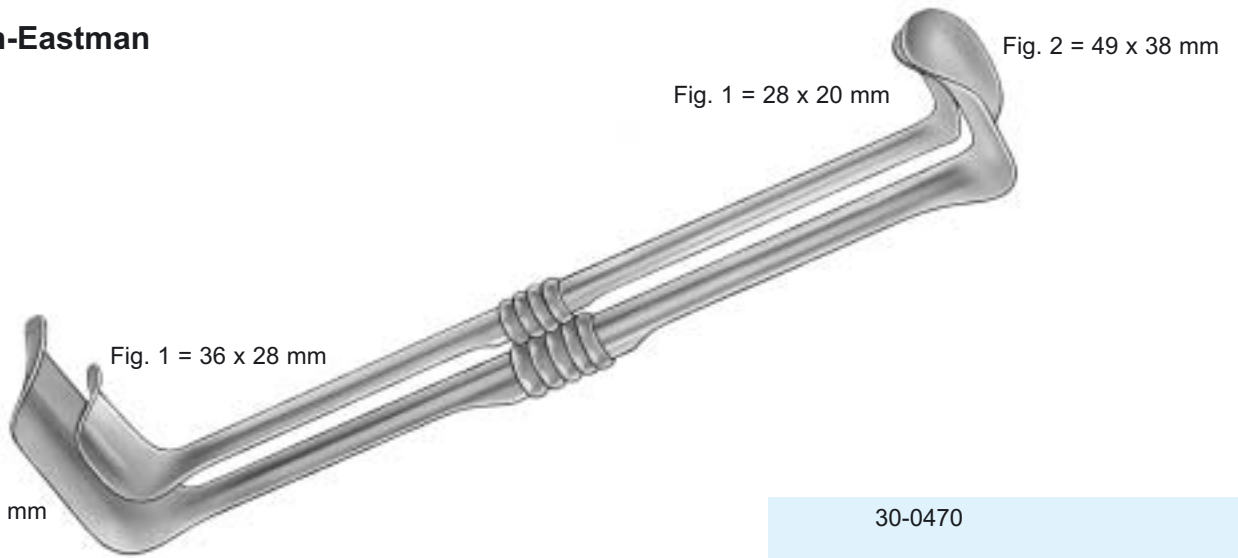

**US-Army
(Parker-Langenbeck)**

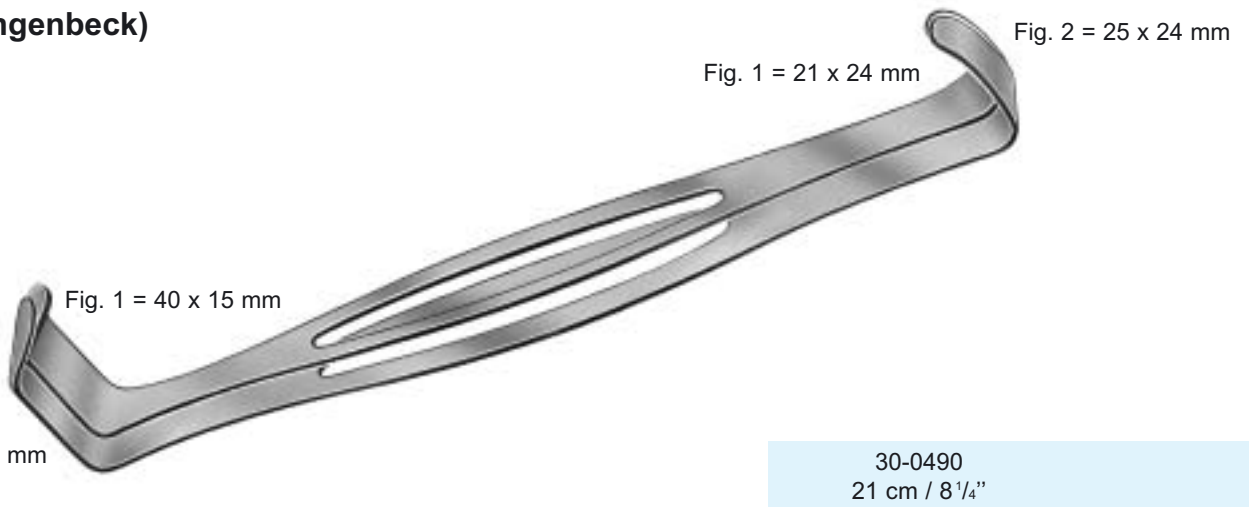

Farabeuf

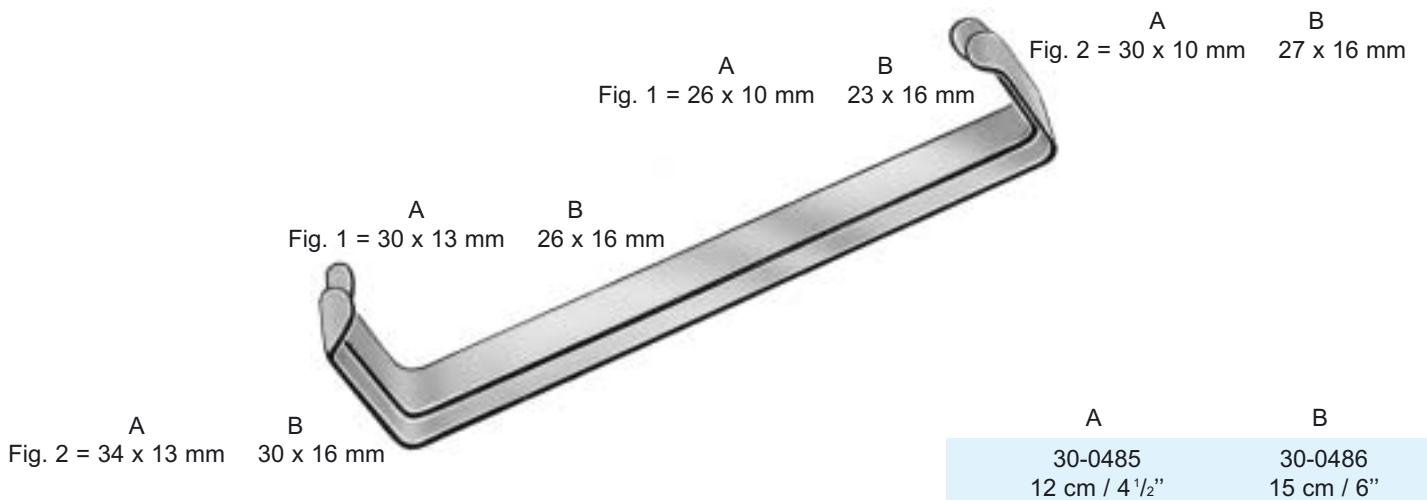

Middeldorpf



Length cm / "	Size mm	Art.-No.
21.5 / 8 1/4	14 x 17	30-0195
22.0 / 8 1/2	20 x 22	30-0196
23.5 / 9	26 x 30	30-0197

Richardson

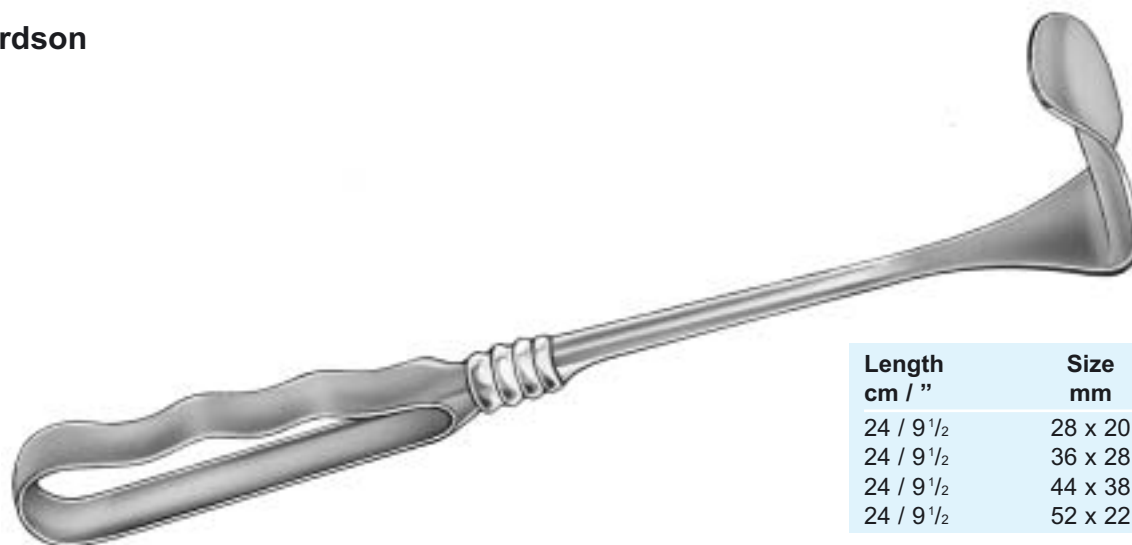

Length cm / "	Size mm	Art.-No.
24 / 9 1/2	28 x 20	30-0471
24 / 9 1/2	36 x 28	30-0472
24 / 9 1/2	44 x 38	30-0473
24 / 9 1/2	52 x 22	30-0474

Kelly

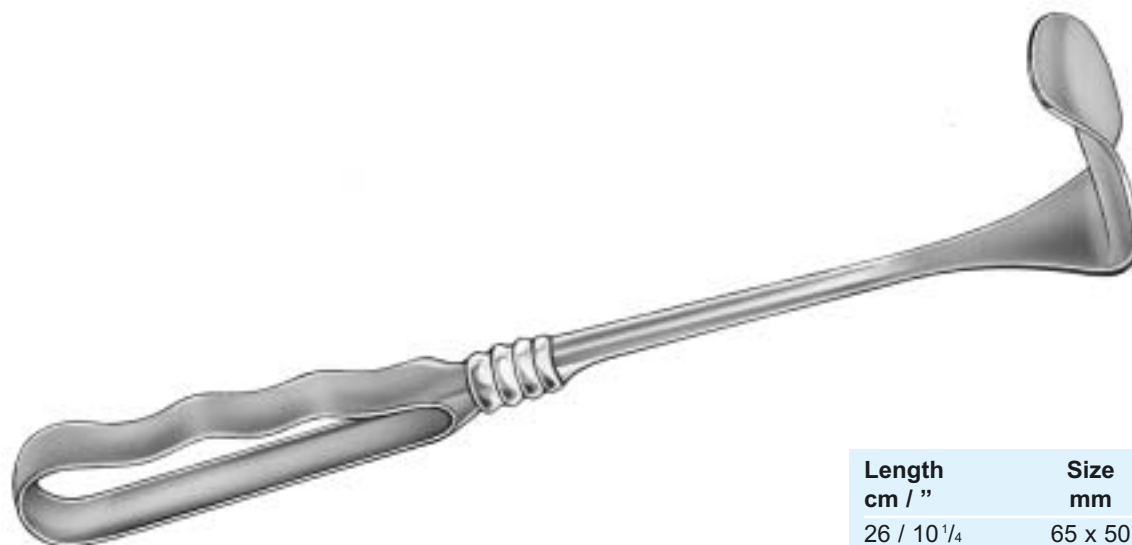

Length cm / "	Size mm	Art.-No.
26 / 10 1/4	65 x 50	30-0475

Roux

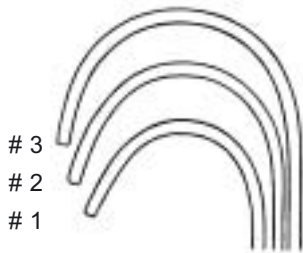

15 x 15 mm

28 x 23 mm

28 x 27 mm



Fig. 1
30-0480.01 20 x 22 mm
25 x 28 mm

Fig. 2
30-0480.02 23 x 26 mm
29 x 38 mm

Fig. 3
30-0480.03 29 x 29 mm
34 x 44 mm

Set Fig. 1-3

30-0480
16.5 cm / 6 1/4"

18 x 21 mm

30-0483
13 cm / 5"

43 x 23 mm

30-0481
16.5 cm / 6 1/4"

45 x 27 mm

30-0482
18 cm / 7"

Desmarres



8 mm

10 mm

12 mm

14 mm

16 mm

18 mm



30-0080
13 cm / 5"

30-0081
13 cm / 5"

30-0082
13 cm / 5"

30-0083
13 cm / 5"

30-0084
13 cm / 5"

30-0085
13 cm / 5"

Mini-Roux

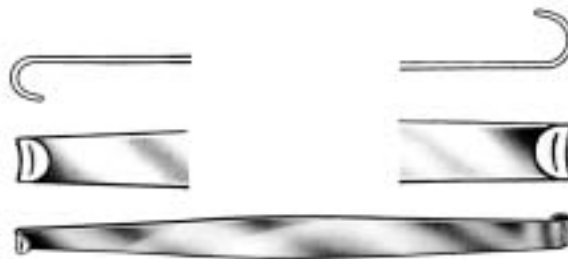

30-0484
15 cm / 6"

Mini-Langenbeck



30-0001 16 cm / 6 1/4", 10 x 6 mm



30-0003 16 cm / 6 1/4", 17 x 5 mm



30-0002 16 cm / 6 1/4", 20 x 6 mm



30-0004 16 cm / 6 1/4", 22 x 8 mm

Kocher



30-0054 23 cm / 9", 40 x 18 mm



30-0055 23 cm / 9", 60 x 20 mm



30-0056 23 cm / 9", 60 x 25 mm



30-0057 23 cm / 9", 75 x 30 mm



30-0058 23 cm / 9", 75 x 40 mm

Volkman



	9 x 8 mm	9 x 13 mm	9 x 19 mm	9 x 29 mm	9 x 40 mm	
sharp	 30-1510 21.5 cm / 8 1/4"	 30-1511 21.5 cm / 8 1/4"	 30-1512 21.5 cm / 8 1/4"	 30-1513 21.5 cm / 8 1/4"	 30-1514 21.5 cm / 8 1/4"	 30-1515 21.5 cm / 8 1/4"
blunt	 30-1530 21.5 cm / 8 1/4"	 30-1531 21.5 cm / 8 1/4"	 30-1532 21.5 cm / 8 1/4"	 30-1533 21.5 cm / 8 1/4"	 30-1534 21.5 cm / 8 1/4"	 30-1535 21.5 cm / 8 1/4"
semi-blunt	 30-1520 21.5 cm / 8 1/4"	 30-1521 21.5 cm / 8 1/4"	 30-1522 21.5 cm / 8 1/4"	 30-1523 21.5 cm / 8 1/4"	 30-1524 21.5 cm / 8 1/4"	 30-1525 21.5 cm / 8 1/4"

Kocher



	15 x 10 mm	15 x 15 mm	15 x 20 mm	15 x 30 mm	15 x 40 mm	
sharp	 30-1540 21.5 cm / 8 1/4"	 30-1541 21.5 cm / 8 1/4"	 30-1542 21.5 cm / 8 1/4"	 30-1543 21.5 cm / 8 1/4"	 30-1544 21.5 cm / 8 1/4"	 30-1545 21.5 cm / 8 1/4"
blunt	 30-1560 21.5 cm / 8 1/4"	 30-1561 21.5 cm / 8 1/4"	 30-1562 21.5 cm / 8 1/4"	 30-1563 21.5 cm / 8 1/4"	 30-1564 21.5 cm / 8 1/4"	 30-1565 21.5 cm / 8 1/4"
semi-blunt	 30-1550 21.5 cm / 8 1/4"	 30-1551 21.5 cm / 8 1/4"	 30-1552 21.5 cm / 8 1/4"	 30-1553 21.5 cm / 8 1/4"	 30-1554 21.5 cm / 8 1/4"	 30-1555 21.5 cm / 8 1/4"

Kocher-Langenbeck



30-0023 21.5 cm/8 1/4", 35 x 15 mm # 5



30-0024 21.5 cm/8 1/4", 40 x 11 mm # 6



30-0025 21.5 cm/8 1/4", 55 x 11 mm # 7



30-0019 21.5 cm/8 1/4", 25 x 6 mm # 1



30-0026 21.5 cm/8 1/4", 70 x 14 mm # 8



30-0020 21.5 cm/8 1/4", 25 x 8 mm # 2



30-0027 21.5 cm/8 1/4", 80 x 12 mm # 9



30-0021 21.5 cm/8 1/4", 35 x 8 mm # 3



30-0022 21.5 cm/8 1/4", 35 x 11 mm # 4



30-0028 21.5 cm/8 1/4", 80 x 16 mm # 10

Langenbeck



30-0009 21 cm/8 1/4", 20 x 7 mm # 0



30-0010 21 cm/8 1/4", 30 x 11 mm # 1



30-0011 21 cm/8 1/4", 30 x 14 mm # 2



30-0012 21 cm/8 1/4", 30 x 16 mm # 3



30-0013 21 cm/8 1/4", 33 x 14 mm # 4



30-0014 21 cm/8 1/4", 40 x 11 mm # 5



30-0015 21 cm/8 1/4", 42 x 13 mm # 6



30-0016 21 cm/8 1/4", 50 x 11 mm # 7

Cushing Vein



30-0130 22.5 cm/9", 13 x 14 mm

Langenbeck

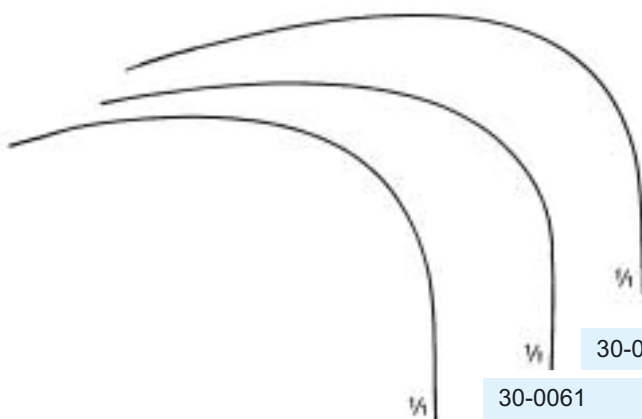

30-0062	63 x 20 mm
30-0061	60 x 20 mm
30-0060	55 x 20 mm

Langenbeck



30-0063	85 x 15 mm
---------	------------

Kocher



30-0450 28 cm / 11", 22 x 15 mm



30-0451 28 cm / 11", 38 x 20 mm



30-0452 28 cm / 11", 67 x 25 mm



30-0453 28 cm / 11", 100 x 35 mm

Fritsch



30-0431 24 cm / 9 1/2", 45 x 40 mm

30-0432 24 cm / 9 1/2", 45 x 50 mm

30-0433 24 cm / 9 1/2", 45 x 60 mm

30-0434 24 cm / 9 1/2", 45 x 75 mm

30-0435 24 cm / 9 1/2", 65 x 85 mm

Kocher



30-0455 22.5 cm / 8 1/2", 70 x 25 mm

Kocher



30-0456 25 cm / 10", 80 x 42 mm

30-0457 25 cm / 10", 80 x 50 mm

30-0458 25 cm / 10", 80 x 60 mm

Mikulicz



30-0380 26 cm / 10 1/4", 155 x 50 mm # 1

30-0381 26 cm / 10 1/4", 120 x 50 mm # 2



30-0386 26 cm / 10 1/4", 85 x 35 mm

Haberer



malleable

30-0345 27 cm / 10 1/2", 25 / 30 mm

30-0346 27 cm / 10 1/2", 37 / 45 mm

30-0347 27 cm / 10 1/2", 40 / 50 mm

Leriche

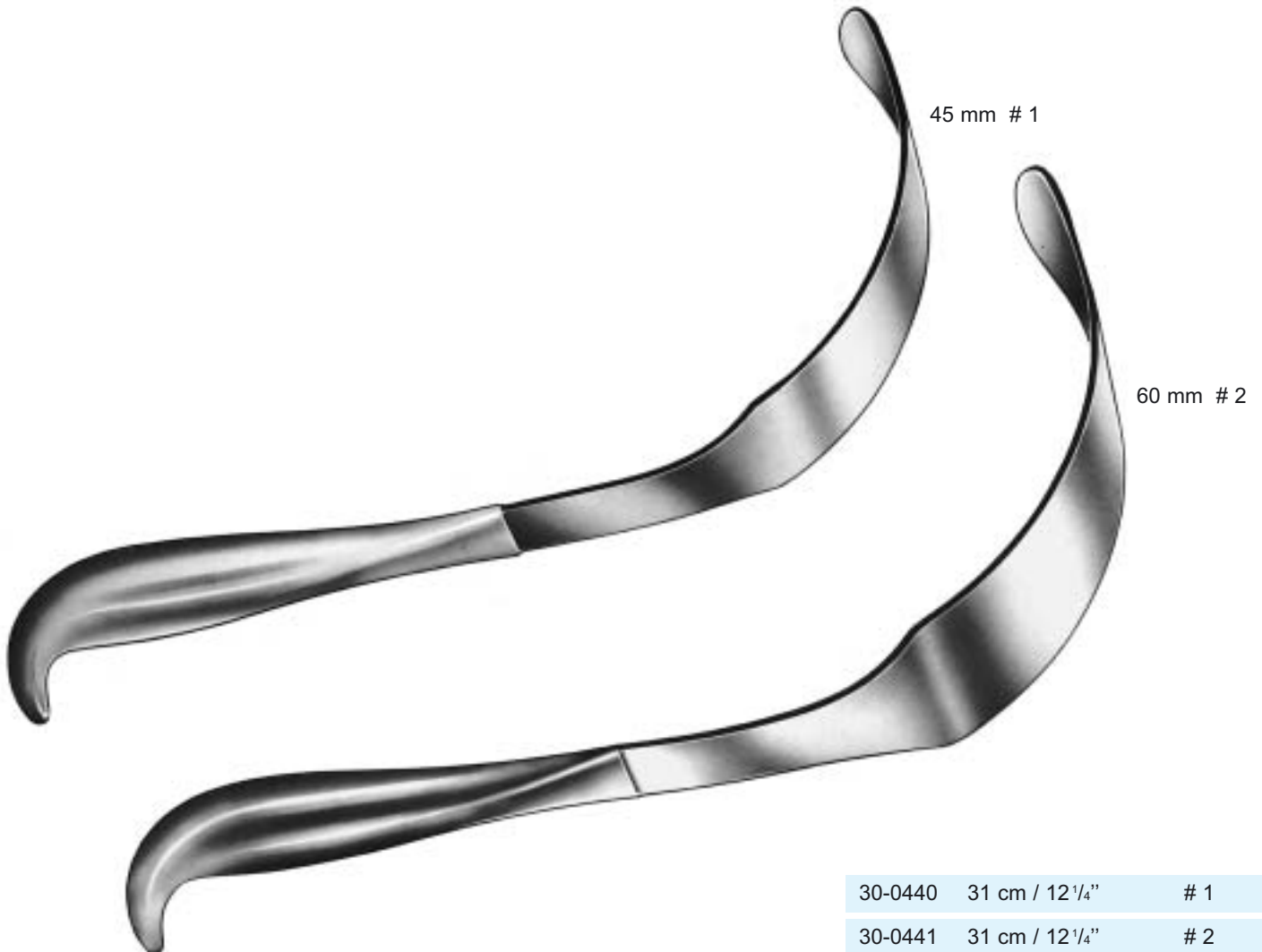

45 mm # 1

60 mm # 2

30-0440 31 cm / 12 1/4" # 1

30-0441 31 cm / 12 1/4" # 2

Kader



30-0340	27 cm / 10 1/2", 20 mm
30-0341	27 cm / 10 1/2", 30 mm
30-0342	27 cm / 10 1/2", 40 mm

Koerte



rigid

30-0344	28 cm / 11", 100 x 45 mm
---------	--------------------------

Copper

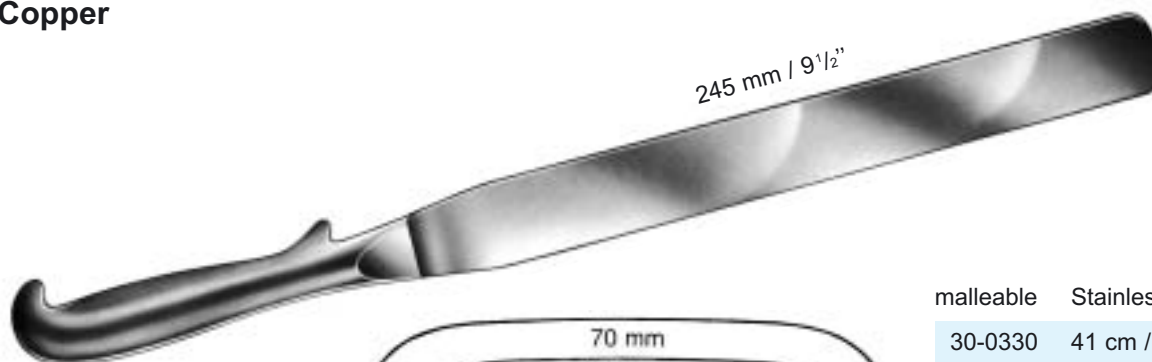

245 mm / 9 1/2"

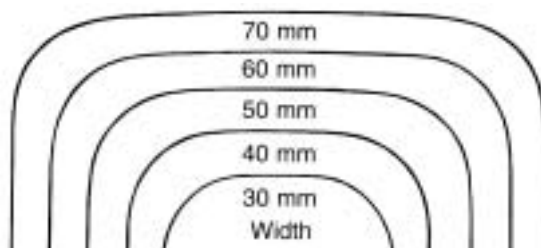

malleable Stainless steel

30-0330	41 cm / 16 1/2", 30 mm
30-0331	41 cm / 16 1/2", 40 mm
30-0332	41 cm / 16 1/2", 50 mm
30-0333	41 cm / 16 1/2", 60 mm
30-0334	41 cm / 16 1/2", 70 mm

Israel



30-0030 25 cm / 10", 40 x 40 mm



30-0031 25 cm / 10", 45 x 50 mm



30-0032 25 cm / 10", 50 x 60 mm



30-0033 25 cm / 10", 70 x 70 mm

Trachea

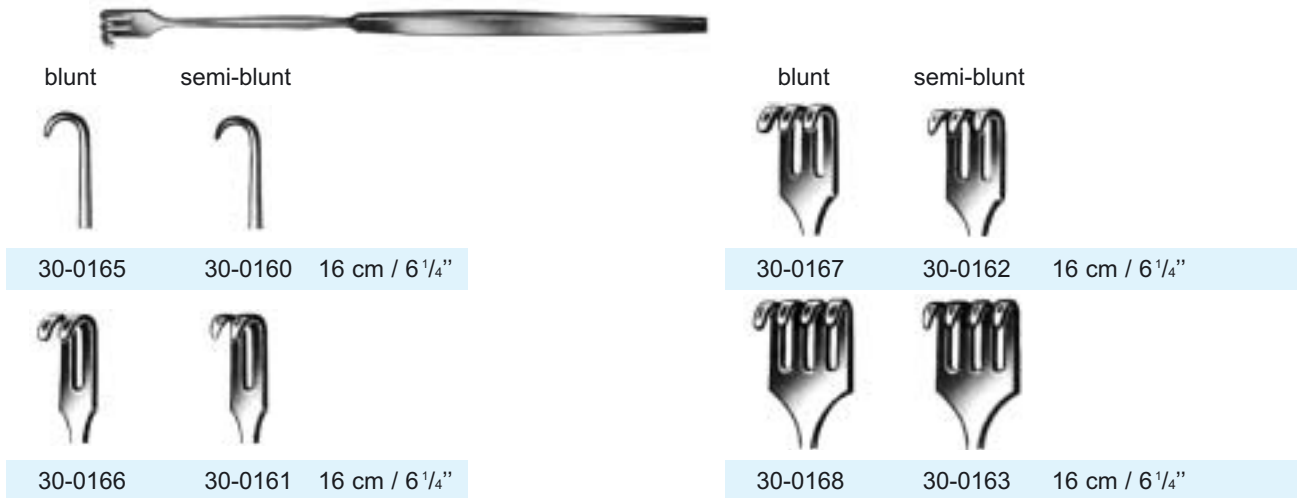

Morse



30-0420	A = 10 mm	23 cm / 9"
30-0422	A = 20 mm	23 cm / 9"
30-0424	A = 30 mm	23 cm / 9"
30-0426	A = 40 mm	23 cm / 9"
30-0428	A = 50 mm	23 cm / 9"

Ragnell-Davis



30-0170	14 cm / 5 1/2"
---------	----------------

Senn-Mueller



sharp	blunt	
30-0175	30-0176	16 cm / 6 1/4"

Moberg



30-0133 17.5 cm / 6 1/2"

Moberg



30-0138 17.5 cm / 6 1/2"

Zenker



30-0153 18.5 cm / 7"

PBI



41-1053 19 cm / 7 1/2"

PBI



41-1015 19 cm / 7 1/2" with ball



Crile

30-0299
14.5 cm
5 1/2"



Crile

30-0300
20 cm
8"



Cushing

30-0304 30-0305
19 cm 19 cm
7 1/2" 7 1/2"

30-0306 30-0307
28 cm 28 cm
11" 11"



sharp

Adson

30-0315
20 cm
8"



blunt

Adson

30-0316
20 cm
8"



Smithwick

30-0310
17 cm
6 1/2"

30-0311
21 cm
8 1/4"



Hoen

30-0275
22 cm
8 1/2"



Nerve,
Vessel and
Suture Hook

Blalock

30-0301
24 cm
9 1/2"



Dandy

30-0281
20 cm
8"



Sachs

30-0312
21 cm
8 1/4"

Lemmon



28-0050

28-0055 17 cm / 6 1/2"

Watson-Cheyne



28-0030

18 cm / 7"

Mc Donald



28-0020

18 cm / 7"



blunt

28-0060

19 cm / 7 1/2"

28-0062

15 cm / 6"

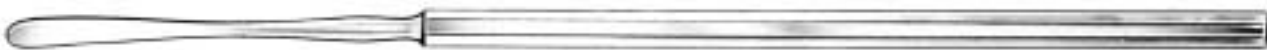

Robb



28-0031.02 2.0 / 1.0 mm 24 cm / 9 1/2"

28-0031.03 3.0 / 1.5 mm 24 cm / 9 1/2"

28-0031.04 4.0 / 2.0 mm 24 cm / 9 1/2"

28-0031.05 5.0 / 2.5 mm 24 cm / 9 1/2"

Freer

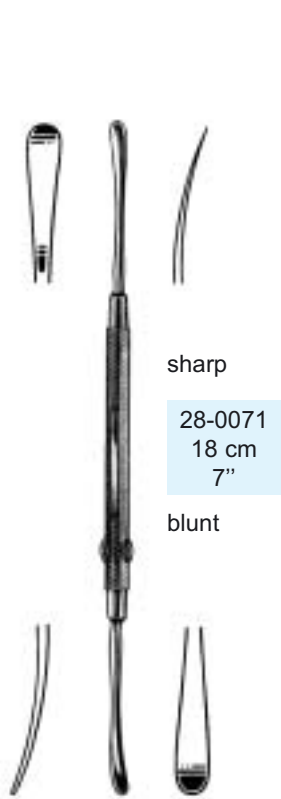

Penfield

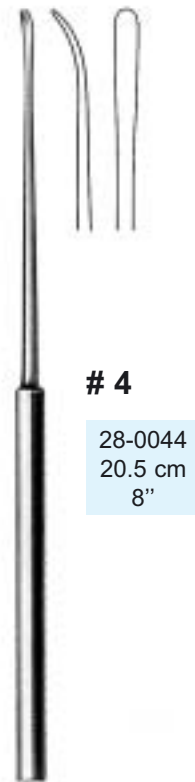
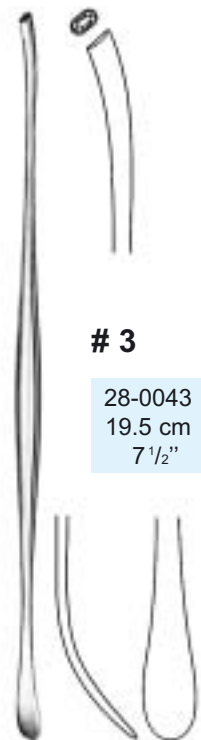
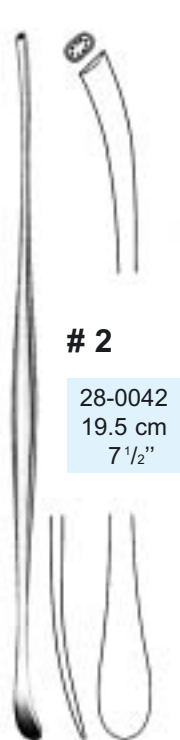
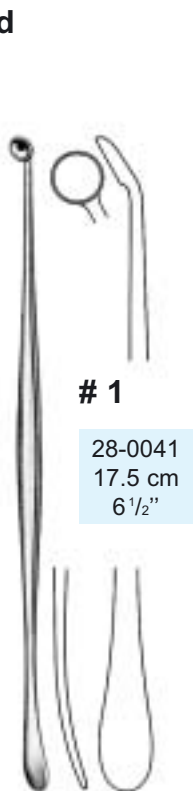

Doyen
Raspatories

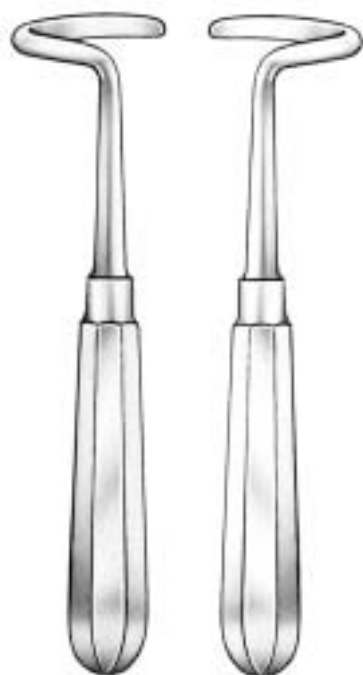

for adults

40-8230 40-8240 17 cm / 6 1/2"



for children

40-8235 40-8245 17 cm / 6 1/2"

Semb
Raspatories



15 mm 15 mm 13 mm 18 mm 12 mm 12 mm 13 mm



40-8202
22 cm
8 1/2"



40-8203
22 cm
8 1/2"



40-8204
22 cm
8 1/2"



40-8205
19.5 cm
7 1/2"



40-8206
21 cm
8 1/4"



40-8207
19.5 cm
7 1/2"



40-8208
21.5 cm
8 1/4"

12.5 mm

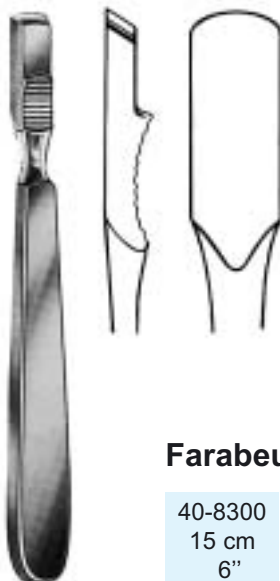

Farabeuf

40-8300
15 cm
6"

12.5 mm



Farabeuf

40-8305
15 cm
6"

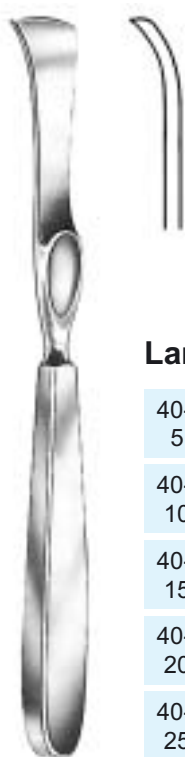

Lambotte

- 40-8345
5 mm
- 40-8350
10 mm
- 40-8355
15 mm
- 40-8360
20 mm
- 40-8365
25 mm

14 mm



Langenbeck

40-8380
18 cm
7"

16 mm



Langenbeck

40-8382
19 cm
7½"